

# MICHIGAN'S 2020 Roads & Bridges ANNUAL REPORT



Michigan  
Transportation Asset  
Management Council

# ACRONYMS AND ABBREVIATIONS

**Any reference to Act 51 in this document refers to Public Act 51 of 1951, as amended.**

ADARS: Act 51 Distribution and Reporting System

APWA: American Public Works Association

BCFS: Bridge Condition Forecasting System

CPM: Capital Preventive Maintenance

CRA: County Road Association (of Michigan)

CSS: Center for Shared Solutions (DTMB)

CTT: Center for Training and Technology (MTU)

DTMB: Department of Technology, Management and Budget

EGL: Department of Environment, Great Lakes, and Energy

FHWA: Federal Highway Administration

FAST: Fixing America's Surface Transportation Act

IBR: Inventory Based Rating (Gravel Roads)

IRT: Investment Reporting Tool

MAC: Michigan Association of Counties

MAR: Michigan Association of Regions

MDNR: Michigan Department of Natural Resources

MDOT: Michigan Department of Transportation

MIC: Michigan Infrastructure Council

MML: Michigan Municipal League

MPO: Metropolitan Planning Organization

MTA: Michigan Townships Association

MTPA: Michigan Transportation Planning Association

MTU: Michigan Technological University

NBI: National Bridge Inventory

NBIS: National Bridge Inspection Standards

NFC: National Functional Classification

NHS: National Highway System

PASER: Pavement Surface Evaluation and Rating

RPA: Regional Planning Agency

STIP: State Transportation Improvement Program

TAMC: Transportation Asset Management Council

TAMP: Transportation Asset Management Plan

WAMC: Water Asset Management Council

**TAMC was created by Public Act (PA) 499 Of 2002**

**To act as a resource for independent objective data on the condition of Michigan's roads and bridges and a resource for implementing the concepts of asset management.**

# TRANSPORTATION ASSET MANAGEMENT COUNCIL (TAMC)

To develop and support excellence in managing Michigan's transportation assets by:

- Advising the Legislature, the Michigan Infrastructure Council (MIC), State Transportation Commission, and transportation committees.
- Promote asset management principles.
- Provide tools and practices for road agencies.
- Collaborate and coordinate with the Water Asset Management Council (WAMC).



## TAMC members for 2020 and the organizations they represent:

- Joanna Johnson (TAMC Chair)**, County Road Association of Michigan  
**William McEntee (TAMC Vice-Chair)**, County Road Association of Michigan  
**Derek Bradshaw**, Michigan Association of Regions  
**Christopher Bolt, P.E.**, Michigan Association of Counties  
**Gary Mekjian, P.E.**, Michigan Municipal League  
**Bob Slattery Jr.**, Michigan Municipal League  
**Jonathan Start**, Michigan Transportation Planning Association  
**Rob Surber**, Michigan Department of Technology, Management and Budget (Non-Voting)  
**Jennifer Tubbs**, Michigan Townships Association  
**Brad Wieferich, P.E.**, Michigan Department of Transportation  
**Todd White**, Michigan Department of Transportation

For added background on TAMC, its members and its related legislation, please visit the *About Us* section on the TAMC website at:

**[www.Michigan.gov/TAMC](http://www.Michigan.gov/TAMC)**

## Special Thanks:

### CSS

John Clark  
Clint Crick  
Nan Ewald  
Cheryl Granger  
Jeri Kaminski

### MDOT

Jacob Armour  
Roger Belknap  
Keith Cooper  
Eric Costa  
Beckie Curtis  
Jesus Esparza  
Mayah Hanson  
Charles Jarvis  
Dave Jennett  
Matt Moulton  
Gloria Strong

### MTU

Tim Colling  
Chris Gilbertson

# INTRODUCTION

The year 2020 posed significant challenges around the globe. However, it also proved to be a year of opportunities. In fact, TAMC developed numerous technology enhancements and hosted its first-ever virtual conference.

## Major takeaways from 2020:

**Virtual Conference** – 2020 cancelled many events, however, TAMC rebounded with its most well attended conference ever. *(See 2020 Year in Review)*

**Roads** – With COVID-19, TAMC had to develop a new method for estimating 2020 federal-aid road conditions and forecast. *(See 2020 Road Condition)*

**Investment Reporting** – To assist with investment strategy discussions, information from the 617 road agencies was used to create average costs for different types of projects. *(See Investment Reporting)*

**Bridges** – Bridge conditions continue to decline, as over 20% of all bridges are forecast to be in the poor or severe condition by the year 2032. *(See 2020 Bridge Condition)*

## Estimated 2020 Federal-Aid Pavement Condition

Percent Lane Miles

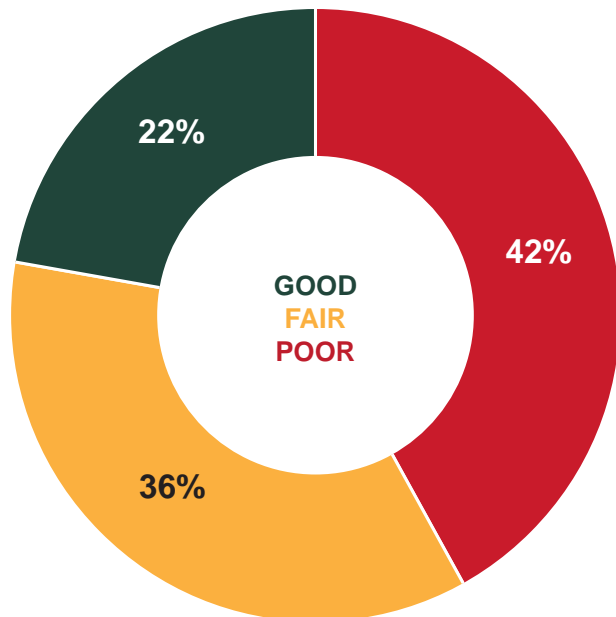

## 2020 Bridge Condition

All Roadway Bridges

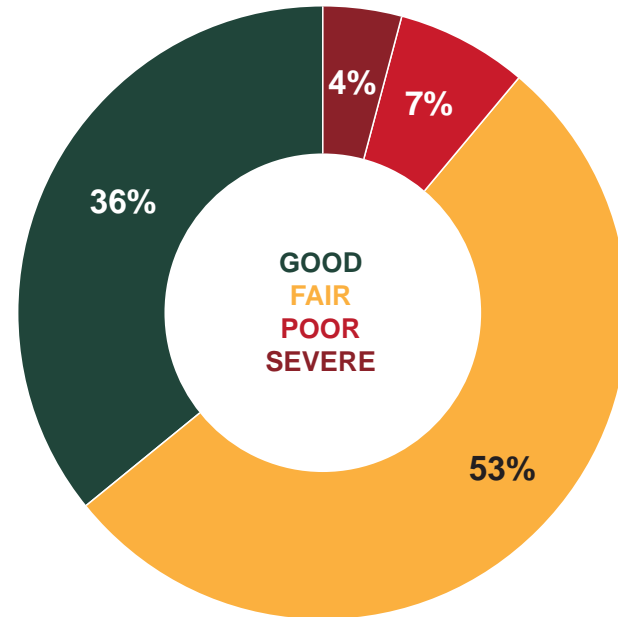

# TABLE OF CONTENTS



Woodward Avenue, Detroit

- 2020 Year in Review..... 1**
  - TAMC Highlights and Accomplishments
  - Transportation Asset Management Plans (TAMP)
  - TAMC Website, Interactive Map and Dashboards
  
- 2020 Road Condition..... 9**
  - Condition Trend 2011-2020
  - Paved Federal-Aid Condition
  - Paved Non-Federal-Aid Condition
  - Pavement Condition Forecast
  
- 2020 Bridge Condition..... 15**
  - Condition Trend 2011-2020
  - Comparing Bridge Conditions
  - Trunkline Bridge Condition
  - Local Agency Bridge Condition
  - Bridge Cycle of Life
  - Bridge Condition Forecast
  
- Investment Reporting..... 23**
  - Investment Reporting Tool (IRT)
  - Road Project Details
  - Bridge Project Details
  - Looking at Asset Management
  - Asset Management Survey
  
- Looking Into 2021..... 29**

# 2020 YEAR IN REVIEW



# TAMC Highlights and Accomplishments

TAMC, like many entities, felt the impact of COVID-19 across its program areas in 2020. This posed many challenges and opportunities, including the first-ever virtual conference appropriately titled, “Adapt and Overcome.” TAMC capitalized on these online formats to provide greater access to training and education.

Even though federal-aid PASER data collection was ultimately suspended, many other core TAMC functions were expanded. Reporting tools and transparency efforts were upgraded with usability enhancements, along with the addition of culvert asset information and legislative map customization. The first round of TAMP submissions required by PA 325 also occurred in 2020.



M-19 Makeover, Huron County - Before



M-19 Makeover, Huron County - After

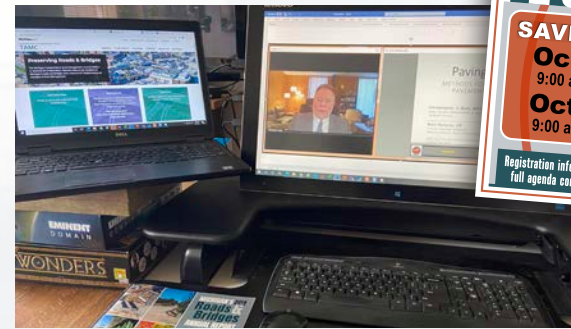

## Virtual Fall Conference “Adapt and Overcome”

The TAMC spring conference was cancelled; however, we adapted and overcame with a virtual TAMC fall conference appropriately titled “Adapt and Overcome.” As more technology options became available throughout the summer, TAMC hosted its most successful conference ever. The virtual fall conference became a two-day event with more than double the attendance from previous events.

The virtual format allowed for an expanded range of speakers while still offering opportunities for peer exchange. Topics included adapting to a digital environment, overcoming current pavement challenges, sharing long-term climate resiliency efforts, and responding to the Tittabawassee River flooding.

To learn more on this conference, including copies of all the presentations please visit:

### ***Asset Management Resources***

To see more on the Tittabawassee River flooding:

### ***Tittabawassee River Flooding Story Map***

TAMC was not alone in adapting and overcoming challenges. Photos from road owning agencies participating in the TAMC fall conference’s “*Extreme Transportation Make Over Challenge*” have been included in this report.

## Training, Work Program and Budget Overview

The majority of TAMC training events were transitioned to a virtual format, as onsite classes were suspended due to COVID-19 restrictions. Many of these virtual events resulted in increased participation from previous years.

Figure 1 shows the numerous training and outreach efforts that are defined in the TAMC work program.

TAMC FY2020 Budget is shown in Figure 2 with a breakdown of all program area expenses. Note: Administrative staff is provided by MDOT and not included in the TAMC budget.

To learn more about the TAMC Work Program and Training Opportunities please visit:

### **Council About Us**

### **2021-2023 Strategic Work Program**

MTU/CTT - Training Programs	Training Events	Number of Participants
Asset Management Conferences	1	250
PASER Training	3 (not including 5 webinars)	182
Asset Management for Elected Local Officials	6	173
Bridge Asset Management Workshop	3 (not including 4 webinars)	32
Inventory Based Rating (IBR) Training	3	215
Paved Asset Management Plan Workshop	7	43
Culvert Eval/Data Webinar	5	109
Asset Management Compliance Plan Webinar	3	46
<i>Figures provided by MTU's 2020 Training Report</i>	<b>Total:</b>	<b>31</b>
		<b>1050</b>

Figure 1  
Source: TAMC 2020

DTMB/CSS - Training Programs	Training Events	Number of Participants
IRT Training	8 (includes 7 webinars)	199

FY2020 Budget Overview	
Regional Program and Data Collection	\$1,116,400
Central Data Agency and Technology	\$380,000
Training and Educational Activities	\$350,000
Council Expenses	\$30,000
<b>Total:</b>	<b>\$1,876,400</b>

Figure 2  
Source: TAMC 2020

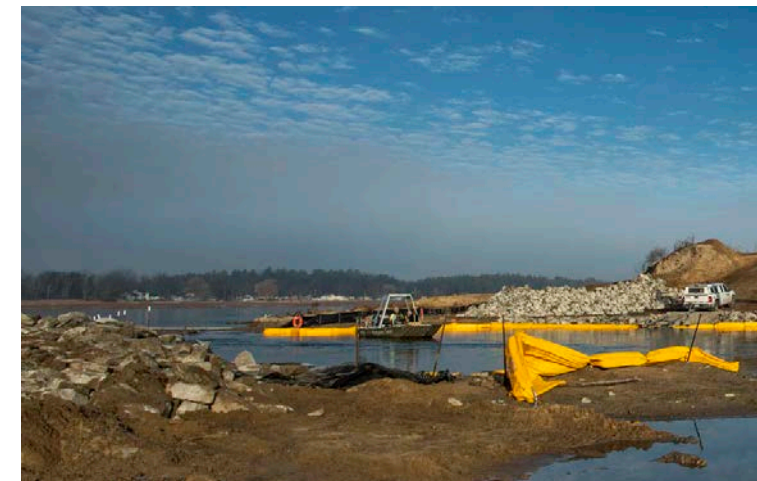





8th Street Makeover, Oshtamo Township - Before



# Transportation Asset Management Plans (TAMP)

2020 marked the first round of submitted TAMPs from local agencies pursuant to Act 51. The TAMPs provide local agencies greater insight into their inventory of assets and future needs. This legislation requires local agencies with 100 or more miles of certified roads to submit a TAMP. The first round of 41 local agencies plans was due October 1, 2020 and another round in 2021 and 2022.

Note: MDOT was required to submit a TAMP to FHWA that was certified on July 12, 2018, with its next TAMP due July 12 of 2022.

TAMP required elements:

1. Asset Inventory
2. Performance Goals
3. Risk of Failure Analysis
4. Anticipated Revenue and Expenditures
5. Performance Outcomes
6. Coordination Clause
7. Proof of Adoption by Governing Body

TAMC has created resources and training opportunities for local agencies to submit a TAMP, including a template that utilizes their previous data collection efforts and dashboard summaries.

The IRT supports this requirement by enabling local agencies to upload their TAMPs and get feedback from TAMC.

To learn more about this requirement, submission schedule, and available resources:

**TAMP FAQs**

**TAMP Due Dates Map**

**TAMP Training and Asset Management Resources**



M-30 at Tobacco River, Gladwin County

# TAMC Website, Interactive Map and Dashboards

## Website

The **TAMC website** is the best resource for information on the condition of the statewide road and bridge system. TAMC provides multiple tools and resources for anyone looking for information on the condition of the road and bridge system and other related efforts. The website provides access to data collected, training opportunities, upcoming meetings, and TAMC policies.

The website provides updated items under its News page along with dedicated pages on TAMC annual conferences and awards. It also provides direct access to current and past TAMC annual reports.

The **Support** page provides resources and contact information for asset management, pilot projects, new legislative developments, and data research studies.

New features in 2020 include updates to the Interactive Map and Dashboards to show provisional culvert data sets. Continued work on the site will improve usability and offer more features.

Many of these tools and resources are used for communications outreach efforts, data access, and planning presentations.

Please check out the TAMC website at [www.Michigan.gov/TAMC](http://www.Michigan.gov/TAMC) and sign up for the **Gov Delivery** to stay connected to any future updates.

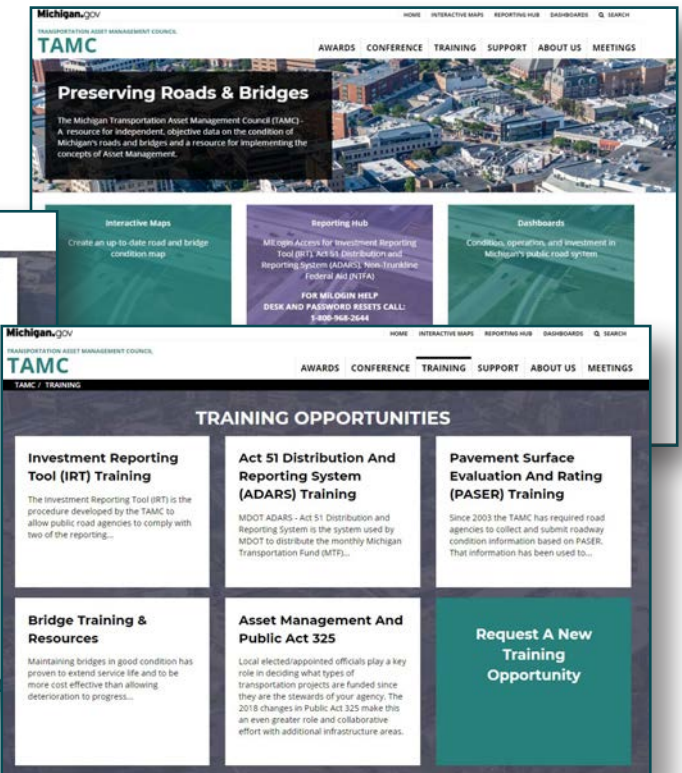
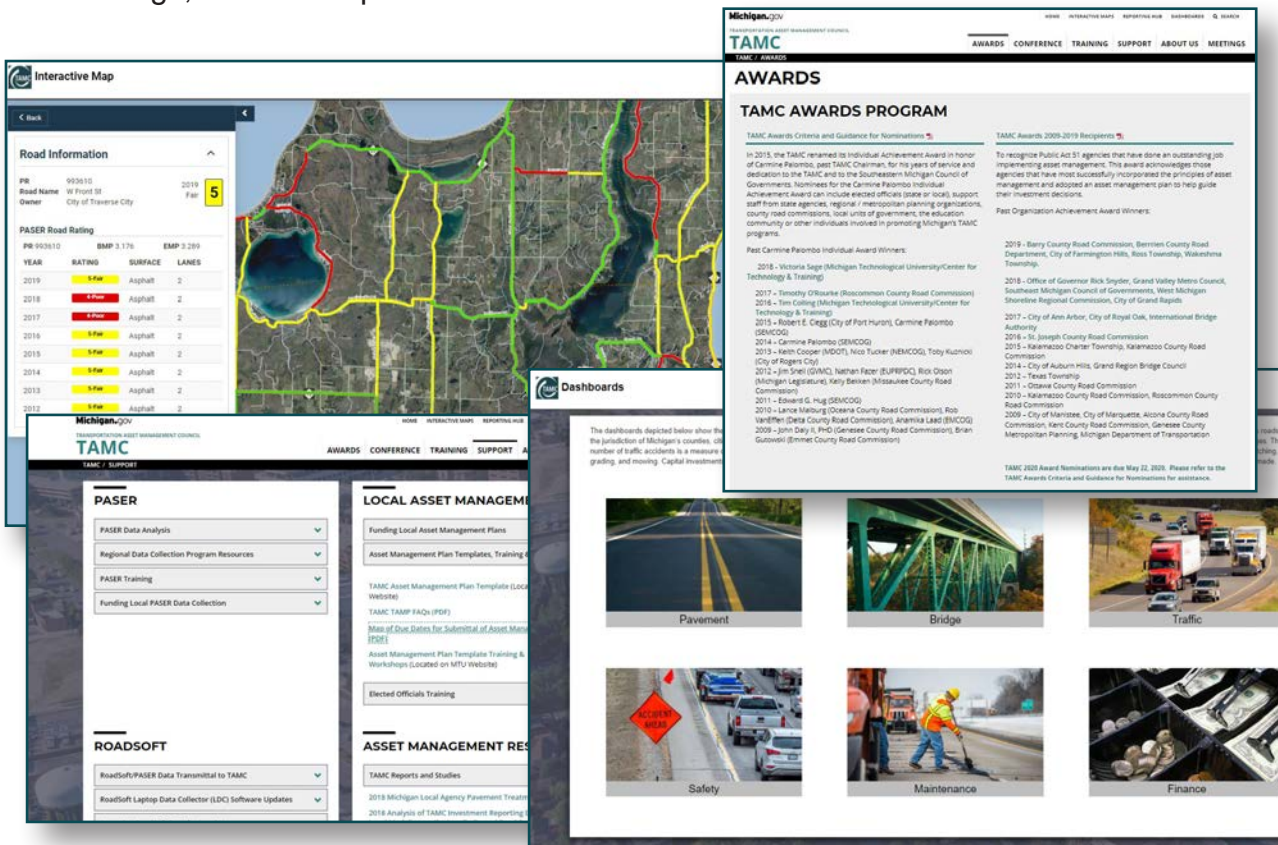

## Interactive Map

TAMC maintains an *interactive map* that displays road and bridge condition statewide and at local levels. Updates occur in May of each year. 2020 marked the addition of provisional culvert data and the improvement of many selection tools. The interactive map is fully mobile and offers ease of use like other common online maps. This is one of TAMC's main transparency efforts, allowing users to view past trends and future coordination of infrastructure improvements.



US-10 Sanford Lake, Midland County

## Performance Measure Dashboards

The *TAMC Dashboards* provide another tool for the public to view numerous data sets in summary format and visual infographics. The dashboards provide road, bridge, financial, traffic, safety, and newly added culvert information.

All information can be customized at local and statewide levels and is fully supported on mobile devices. Click on each graphic for direct hyperlinks to the specific Performance Measure Dashboard.

**Interactive Map**

Search by location, street, or bridge

Map Options: Street, Aerial, Hybrid, County Outlines

Map Layers: Road Ratings, Bridge Ratings, Culverts (Provisional Data)

Rating: Severe, Poor, Fair, Good

**Michigan.gov**

**IMAP**

**Culvert Information**

Location	Peninsula Dr
Material	Concrete
Rating	Good
Rating Date	6/21/2018
Number of Culverts	1
Shape	Circular
Length	35

**PAVEMENT**

Please choose a Pavement Report from the below options:

- Pavement Conditions
- Trend Analysis
- Pavement Forecast
- Non-Fed Aid
- Pavement Comparison

**FINANCIAL**

- Expenditures
- Revenue
- Revenue Trends

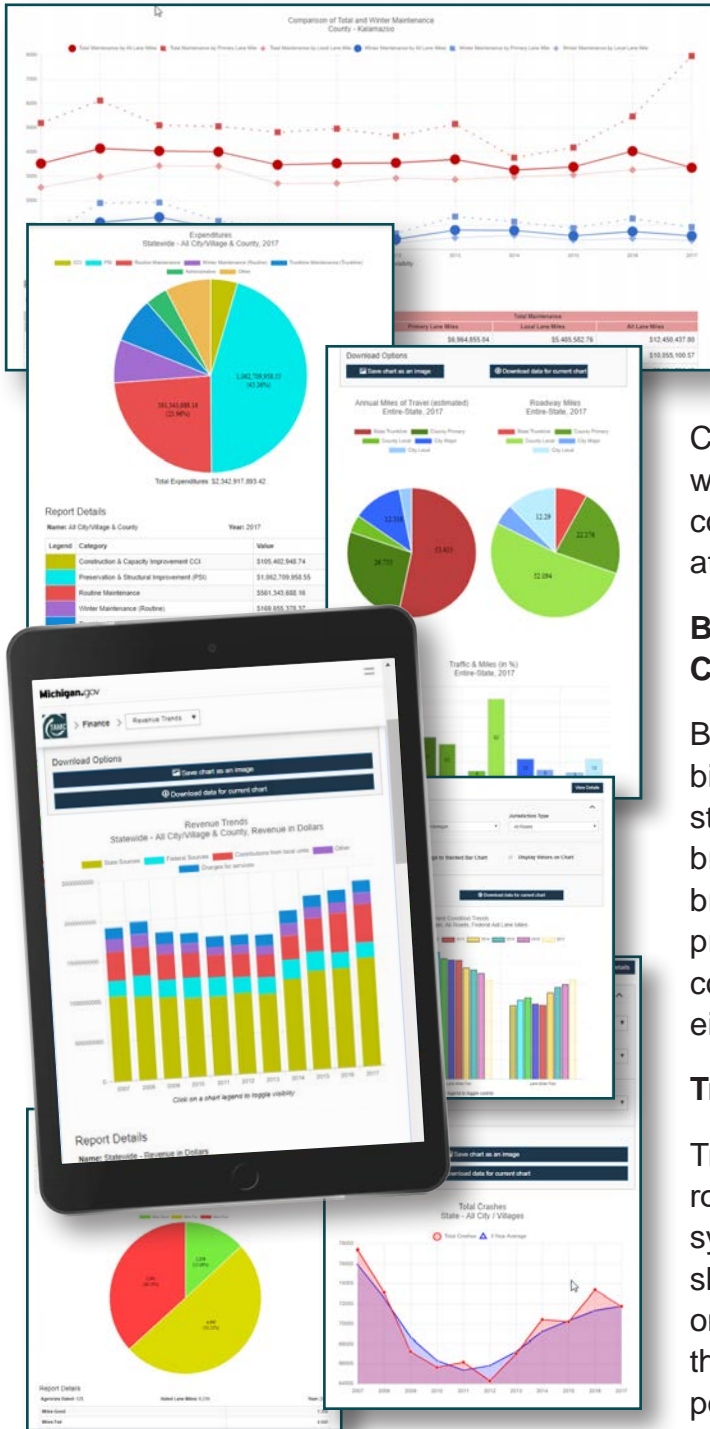

## Pavement Condition and Comparison Dashboards

These dashboards are based on PASER ratings for all state trunklines, including roads under the jurisdiction of Michigan’s state, counties, cities, and villages. These dashboards illustrate past and present conditions and future forecast trends. The

Comparison Dashboard provides the user with the ability to compare current road conditions for up to eight road agencies at one time.

## Bridge Condition and Comparison Dashboards

Bridge conditions are based on bi-annual inspections of over 11,000 state, county, city, and village owned bridges. These dashboards illustrate bridge conditions and trends which provides the user with the ability to compare system performance for up to eight bridge agencies at one time.

## Traffic Dashboard

Traffic volumes are a measure of both road use and how effectively the road system is performing. This dashboard shows estimated annual miles of travel on Michigan’s roads and a comparison of the relative sizes (in centerline miles) of portions of Michigan’s road network.

## Safety Dashboard

The rate of crashes (fatalities, serious injuries) is a measure of how effectively the road system is performing related to safety measures. This dashboard was designed using federal performance metrics.

## Maintenance Dashboard

This dashboard provides a county-by-county comparison of winter maintenance expenses that are necessary to keep roads and bridges performing during winter maintenance operations.

## Finance - Revenues and Expenditures Dashboards

These dashboards illustrate how Michigan’s road agencies are investing in their roads and bridges, along with the revenues received by each agency. Counties can link to TAMC’s website to meet an Act 51 financial performance dashboard requirement.

## Culvert Provisional Data Dashboard

This new dashboard features the 2018 Culvert Inventory Pilot efforts. It provides a preview as this new asset is added to many TAMC efforts.





# 2020 ROAD CONDITION



One of TAMC's first charges is to determine the condition of paved federal-aid roads, which accounts for 1/3 of Michigan roads and carries over 95% of the traffic. Beginning in 2003, MDOT, county, regional, and metropolitan planning agencies joined together to pursue this statewide effort. Under the direction of TAMC, Pavement Surface Evaluation and Rating (PASER) was the measure chosen to identify the condition of pavements. Road professionals evaluate surface condition on a 1-10 scale, which is then consolidated into three categories: good, fair, and poor.

PASER Condition Ratings		
8-10	Good Condition	Routine maintenance candidate.
5-7	Fair Condition	Preventative maintenance or rehabilitation candidate.
1-4	Poor Condition	Rehabilitation or reconstruction candidate.

With COVID-19 restrictions, the condition of federal-aid roads was not collected in 2020; therefore, a 2020 estimated condition was developed from the 2018 and 2019 PASER.

As shown in Figure 3, in 2020, 42% of all paved federal-aid roads, or 36,700 lane miles, are estimated in poor condition. Paved federal-aid roads are expected to continue to be in poor condition without significant increases in investment. See the Pavement Condition Forecast section for more details.

# Paved Federal-Aid Road Condition

2011-2020

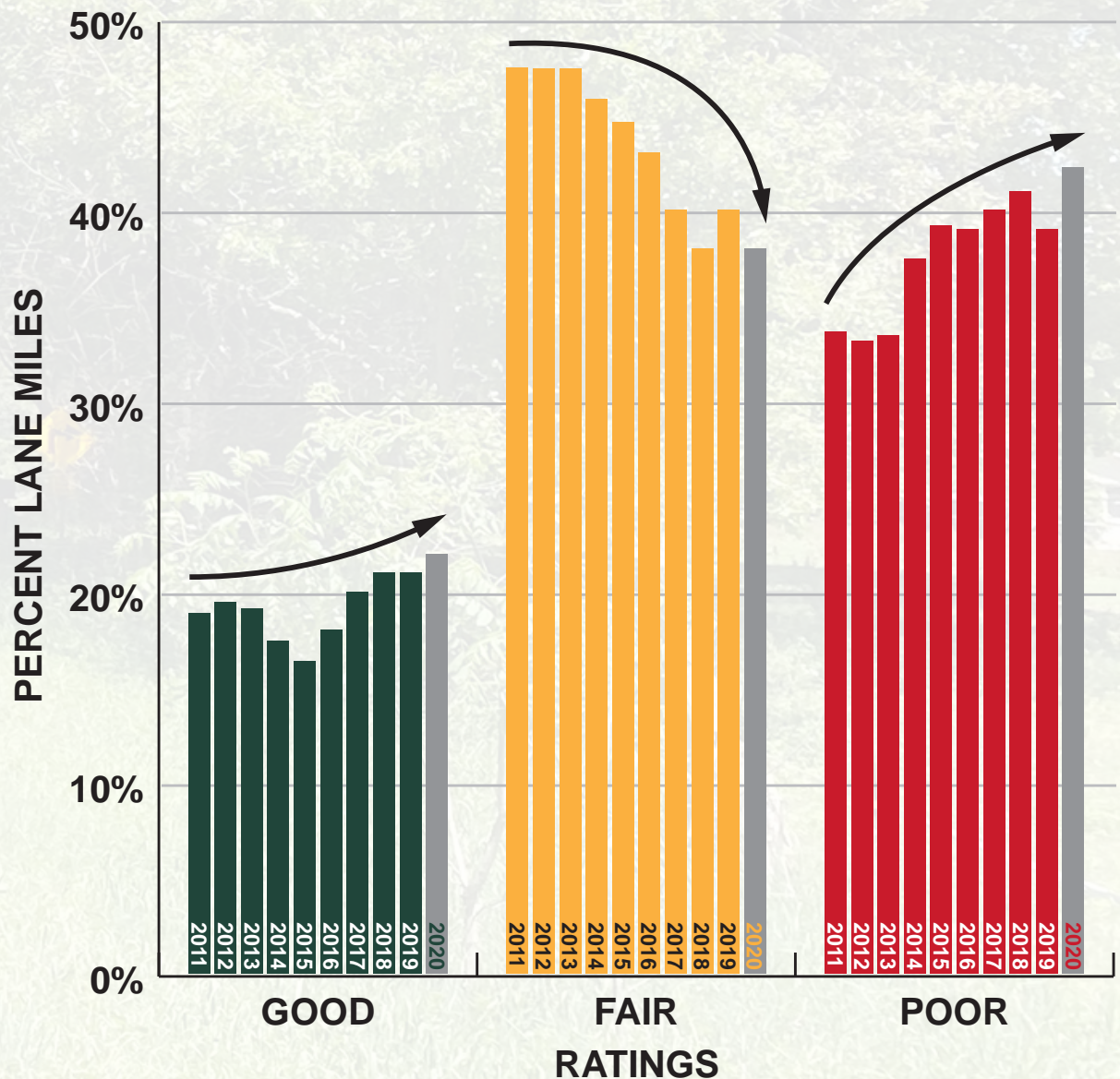

Figure 3

Source: 2011-2020 PASER Data Collection

# Estimated 2020 Federal-Aid Pavement Condition

Percent Lane Miles

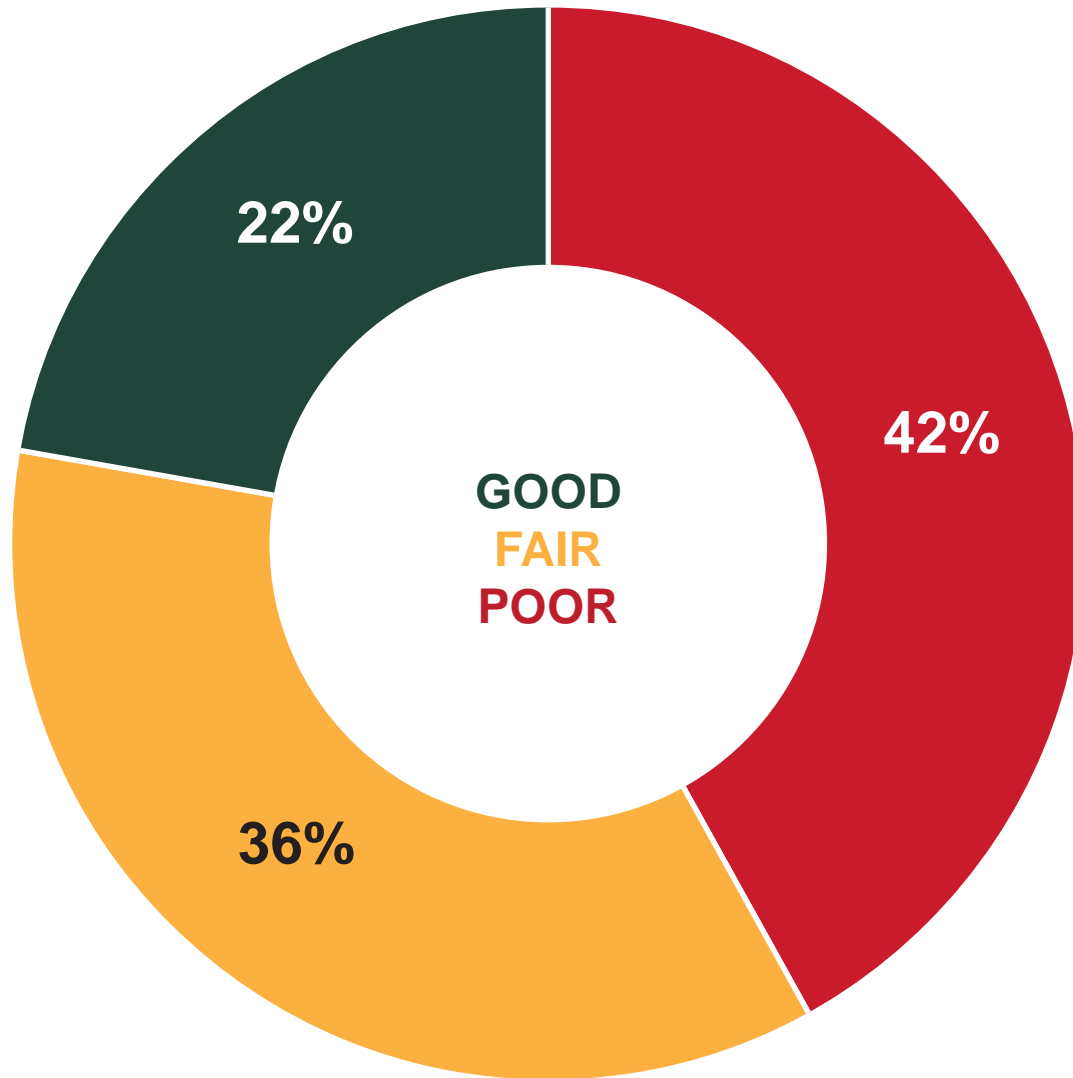

Figure 4

Source: 2020 Estimated PASER Data

## Paved Federal-Aid Roads

Road agencies typically report on the condition of all paved federal-aid roads over the course of two years. This creates a composite of the best available data sets for the entire federal-aid road network of 88,000 lane miles. With no collection of condition data on the federal-aid network in 2020, the system condition is estimated for a single year.

Factors used in this estimation include:

- Expected revenue
- Deterioration rates
- Construction costs
- 2018-2019 federal-aid conditions

Figure 4 shows a summary of the 2020 estimated system condition. From the previous year, a slight increase of roads in good condition occurred while roads in fair condition decreased. Roads in poor condition increased by 3%, or 2,700 lane miles,

This increase raises the total to nearly 37,000 lane miles of the federal-aid road network estimated to be in poor condition.



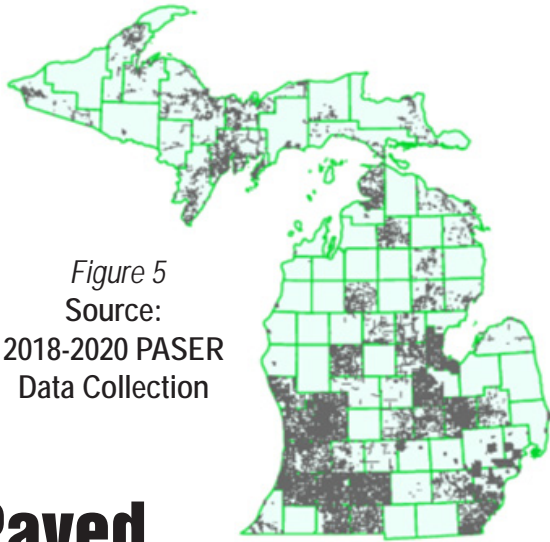

Figure 5  
Source:  
2018-2020 PASER  
Data Collection

## Paved Non-Federal-Aid Roads

There are over 165,000 lane miles of non-federal-aid roads in Michigan. The federal government classifies these roads as being “Local Roads.” Each year, many local agencies choose to rate some or all their paved non-federal-aid roads.

The ratings are typically done on a 3-year cycle. In 2020, 21,202 lane miles were rated. Figure 5 shows from 2018-2020, close to 300 local agencies reported ratings on 50,218 lane miles. Of these roads, 50% were found to be in poor condition as seen in Figure 6.

Local agencies use ratings on both federal-aid and non-federal-aid roads to help manage their road network.

## 2018 - 2020 Non-Federal-Aid Pavement Condition

Percent Lane Miles

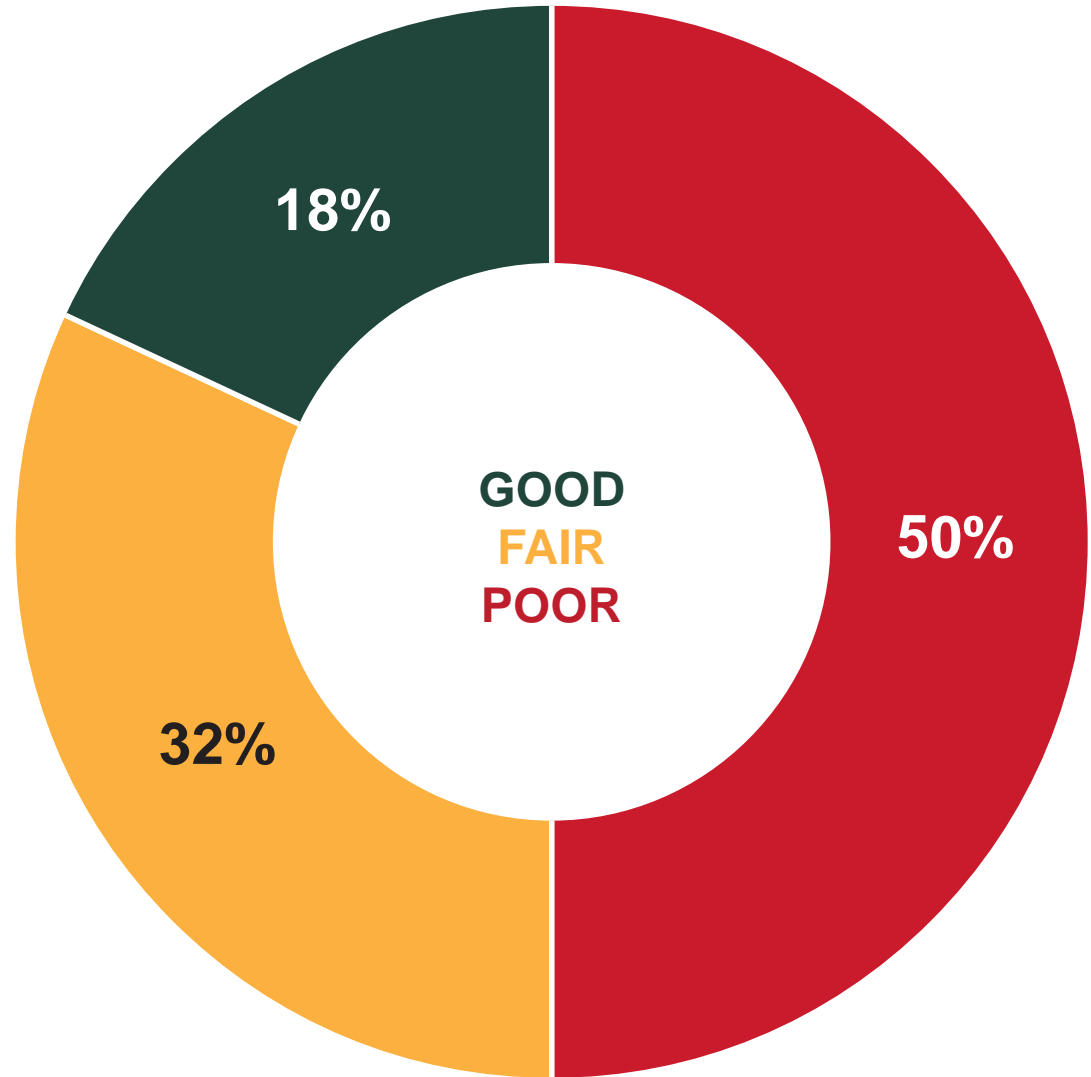

Figure 6  
Source: 2018-2020 PASER Data Collection

# Pavement Condition Forecast

## Approach for 2022-2032

The Pavement Condition Forecasting System (PCFS) estimates the future condition of pavements. Examples of criteria that support the PCFS include current pavement condition (PASER), road deterioration rates, project costs, expected inflation, fix strategies, and revenues.

As mentioned, COVID-19 prevented any new data collection on the 2020 federal-aid roads. When doing the 2022 to 2032 pavement forecast, the 2020 estimated condition was used to offset the missing 2020 PASER ratings.

Another adjustment to the 2022-2032 forecast takes into consideration that regions across the state have different challenges when it comes to road repairs and improvements.

TAMC began collecting treatment type costs as a part of the Investment Reporting Tool. This information was used to determine the varying treatment type costs across the state.

Factors that affect the repairs and improvement costs are:

- Size of the project
- Where it is located
- Impact of frost freeze levels
- Exposure to extreme heat

National Functional Class (NFC) was also introduced as a factor because traffic volumes can vary greatly by regions across the state.

All these factors can cause stress to pavement and requires the pavement be constructed and maintained according to its location.



Pothole Filling in Ann Arbor, Washtenaw County

Using these more representative regionally based treatment type costs, individual regional forecasts were developed for 2022-2032. These forecasts were then combined to predict the future condition of pavements across the state.

The statewide pavement forecast indicates a continued decline in the federal-aid roads as seen in Figure 7. By 2032, it is forecast that only 20% of the roads will be in good condition while roads in fair condition will stay consistent. Over those 10 years the roads in poor condition will reach 46%.

In 2022 roads are expected to slightly improve from the 2020 estimated condition. This is primarily due to an allocation of \$274M on the federal-aid system from the Coronavirus Response and Relief Supplemental Appropriations Act, 2021.

However, this type of short-term investment results in pavement condition improvements in the initial years where the condition then declines over time.

Without additional long-term investment in the billions, the percent of roads in poor condition will continue to increase, as the deterioration rate of roads outpaces the ability to fix them.

# Pavement Condition Forecast

2022-2032

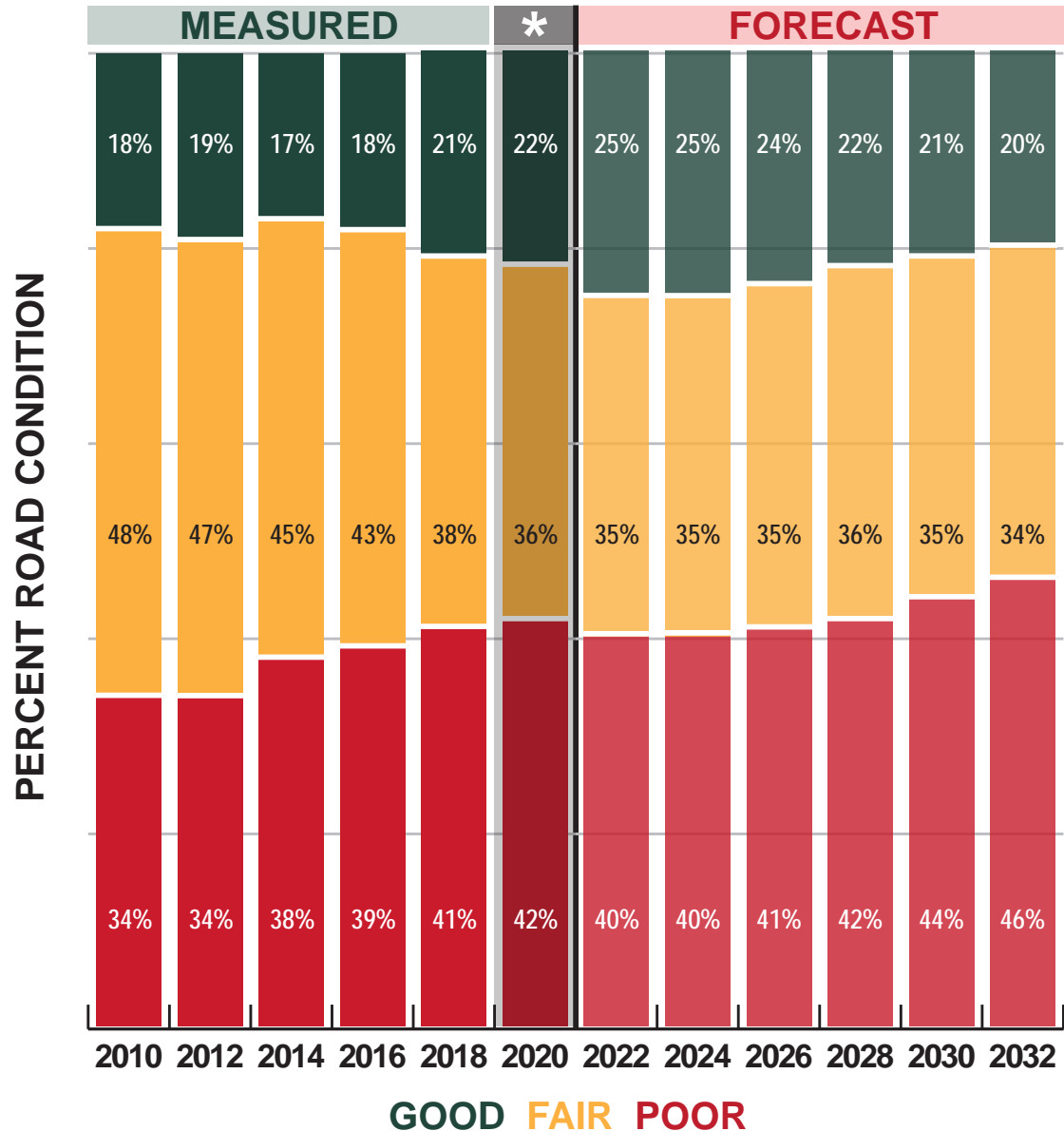
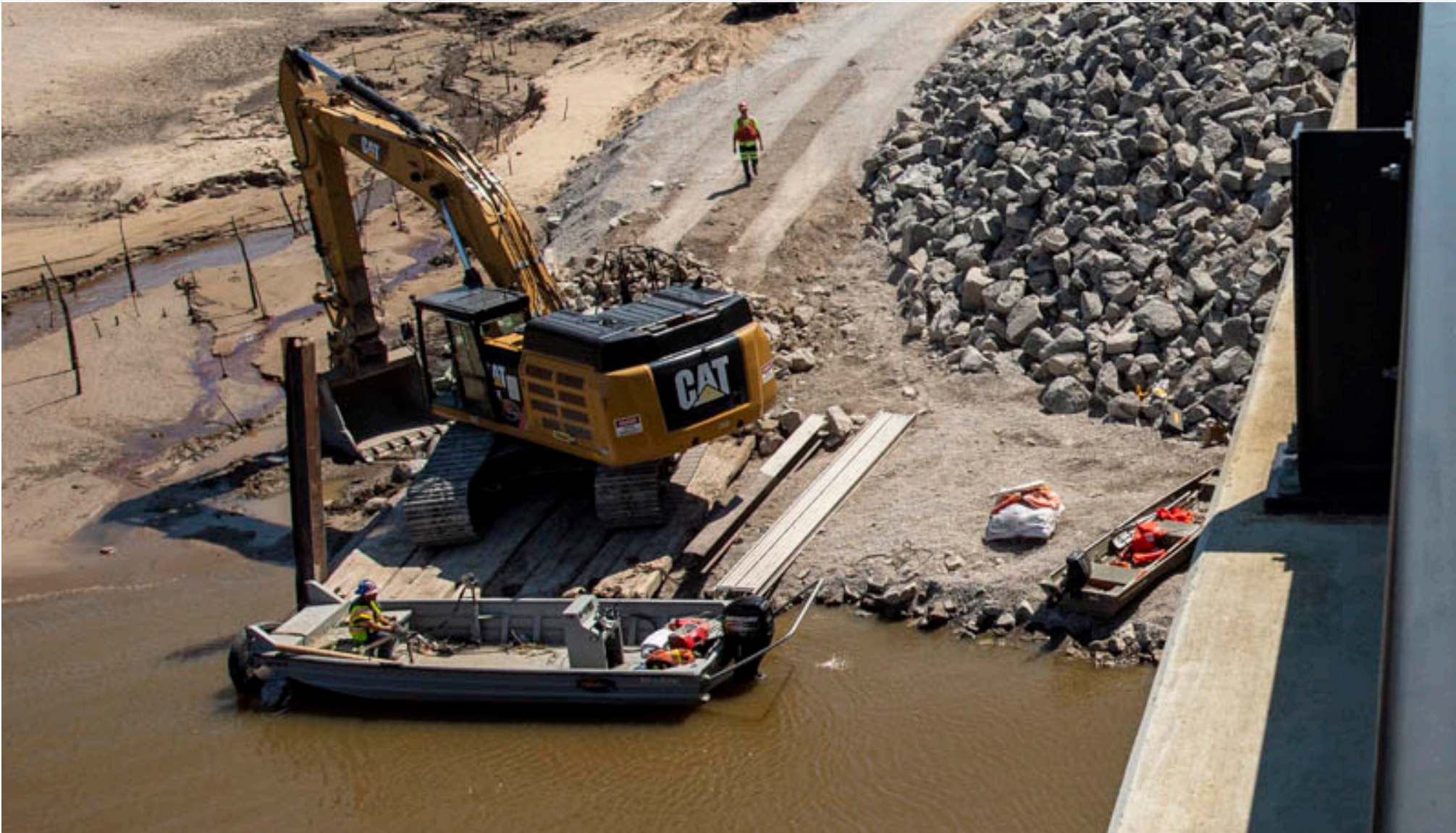

Figure 7

Source: 2021 TAMC

# 2020 BRIDGE CONDITION



The National Bridge Inspection Standards (NBIS) define a bridge as a structure carrying traffic with a span greater than 20 feet. Condition ratings are based on a 0-9 scale and assigned for each culvert, or the deck, superstructure, and substructure of each bridge. These ratings are recorded in the National Bridge Inventory (NBI) database.

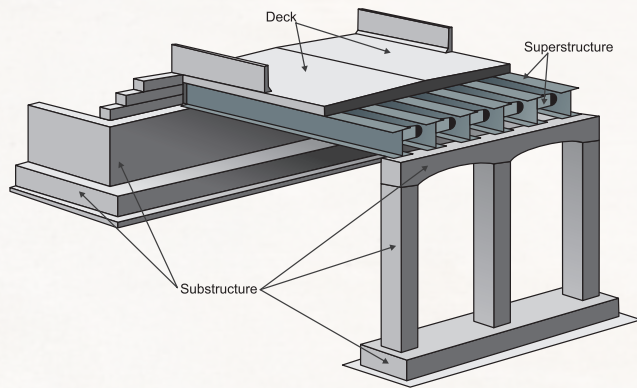

As shown in Figure 8, in 2020 over 1200 bridges or 11% of NBI structures are in poor condition. Given the current rate of bridge deterioration, bridges in poor condition will continue to increase until significant increases in investment are made.

# Statewide Bridge Condition

2011-2020

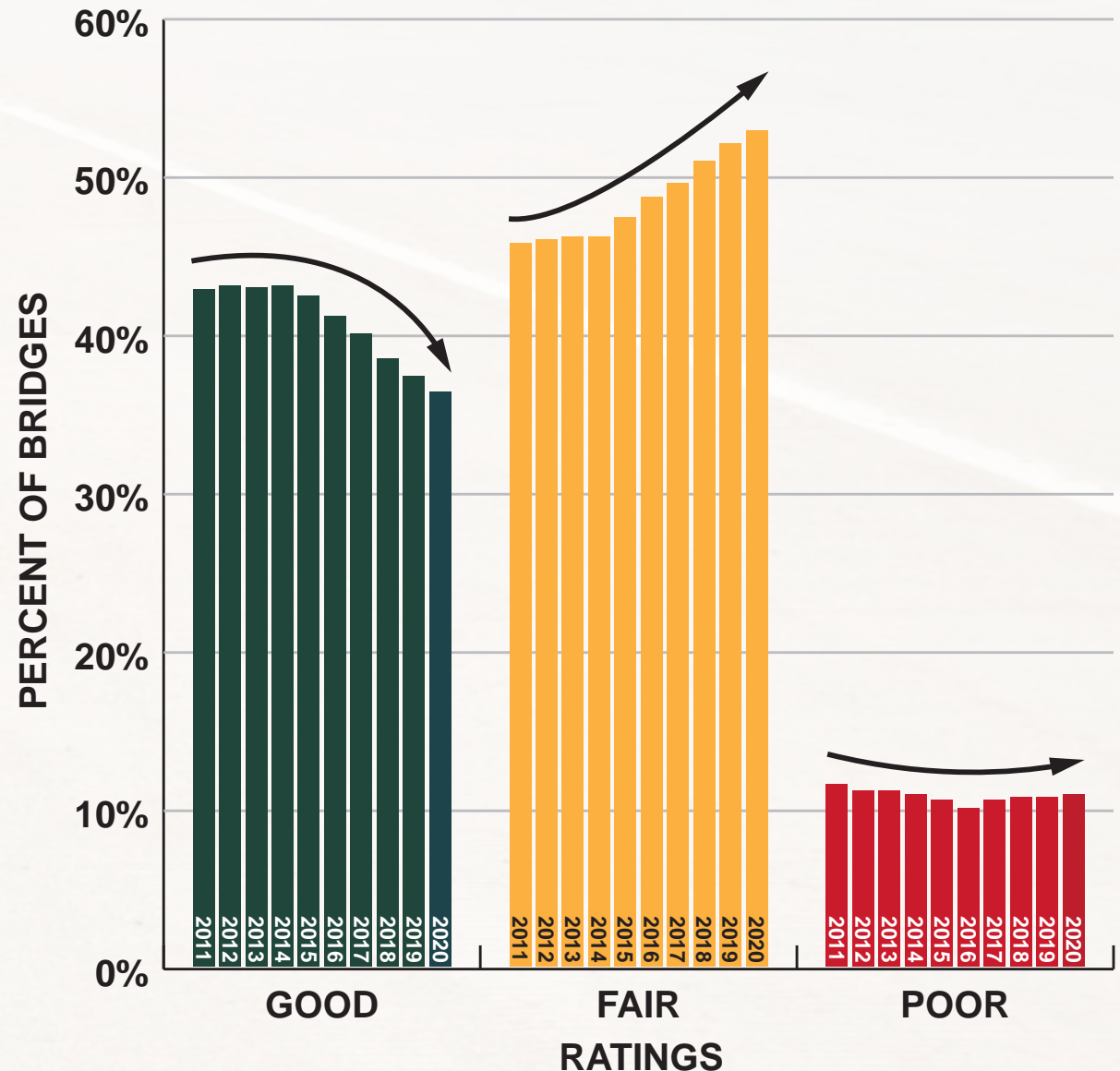

Figure 8

Source: 2011-2020 Michigan Bridge Inventory



Pedestrian Bridge, Grand Rapids

# Comparing Bridge Condition

Michigan lags behind its neighboring Great Lakes States in terms of bridge condition. As seen in Figure 9, Michigan has the highest percentage of poor bridges in the Great Lakes Region, and also has significantly more poor bridges than the national average. More concerning, when measuring the bridges in Severe Condition, or those requiring additional monitoring, immediate action, or at risk of closure, Michigan has double the percentage of bridges with NBI ratings of 3 or less.

NBI Condition Ratings		
7-9	Good Condition	Routine maintenance candidate.
5-6	Fair Condition	Preventative maintenance or minor rehabilitation candidate.
4	Poor Condition	Major rehabilitation or replacement candidate.
2-3	Severe Condition	Serious or Critical Condition
0-1	Imminent Failure or Failed	Major rehabilitation or replacement candidate. Bridge is closed to traffic.

## 2020 Percent Poor Bridges

NBI 4 or Less

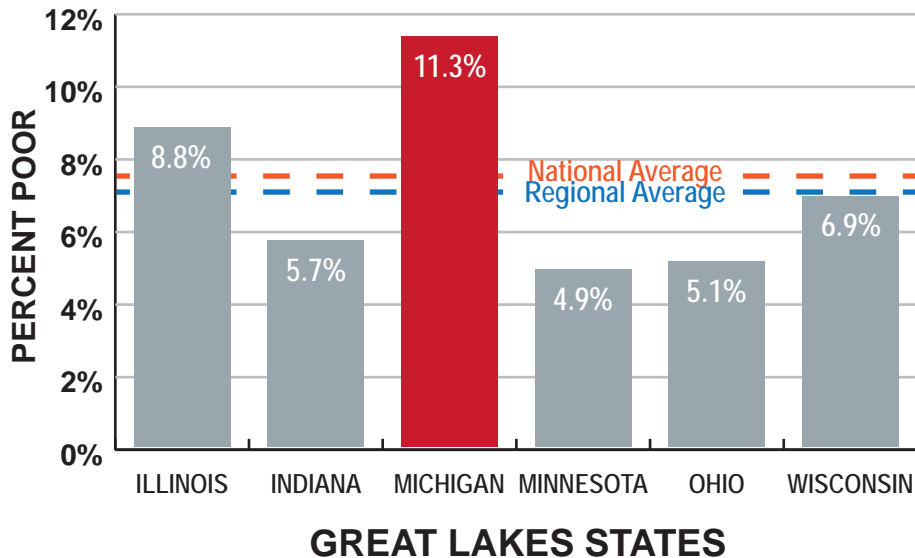

## 2020 Percent Severe Bridges

NBI 3 or Less

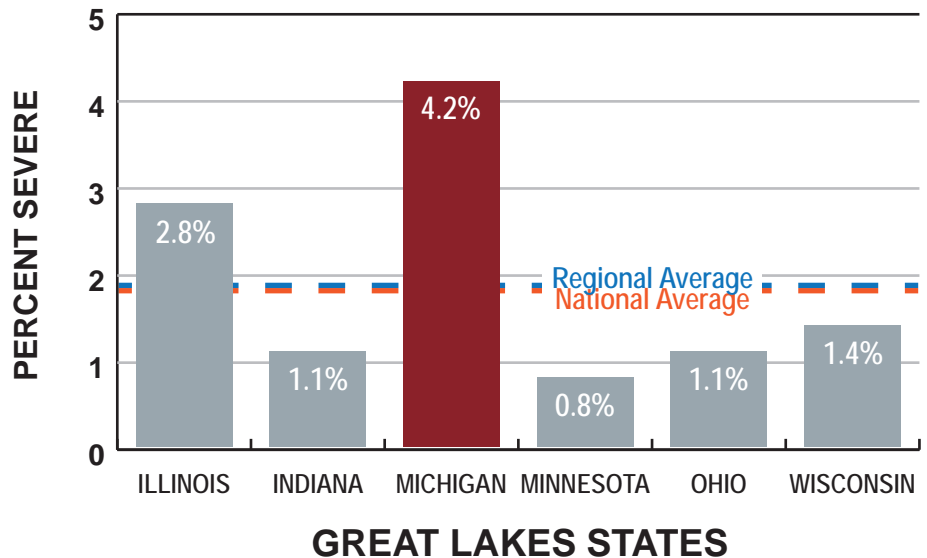

Figure 9

Source: 2020 National Bridge Inventory

# Trunkline Bridges

Unlike roads, all bridges are considered federal-aid eligible. Figure 10 shows that MDOT has nearly 7% of its bridges in poor or severe condition and 67% of bridges are in fair condition. This large population of bridges in fair condition represents the previous investments in preservation. Until recently, MDOT has been able to maintain the number of bridges in fair condition before they reach the poor category, while increasing the number of bridges in good and fair condition. An aging infrastructure and rising costs along with stagnant funding or not enough existing revenue or lack of new revenue to maintain our aging bridges, have reversed some of that progress.

The number of bridges in fair condition has increased, and since 2017 the number of bridges in poor condition has increased as preservation needs exceed available revenues. Maintaining or improving the bridges rated in good or fair condition is imperative to prevent the number of bridges in the poor category from increasing further.

# 2020 Trunkline Bridge Condition

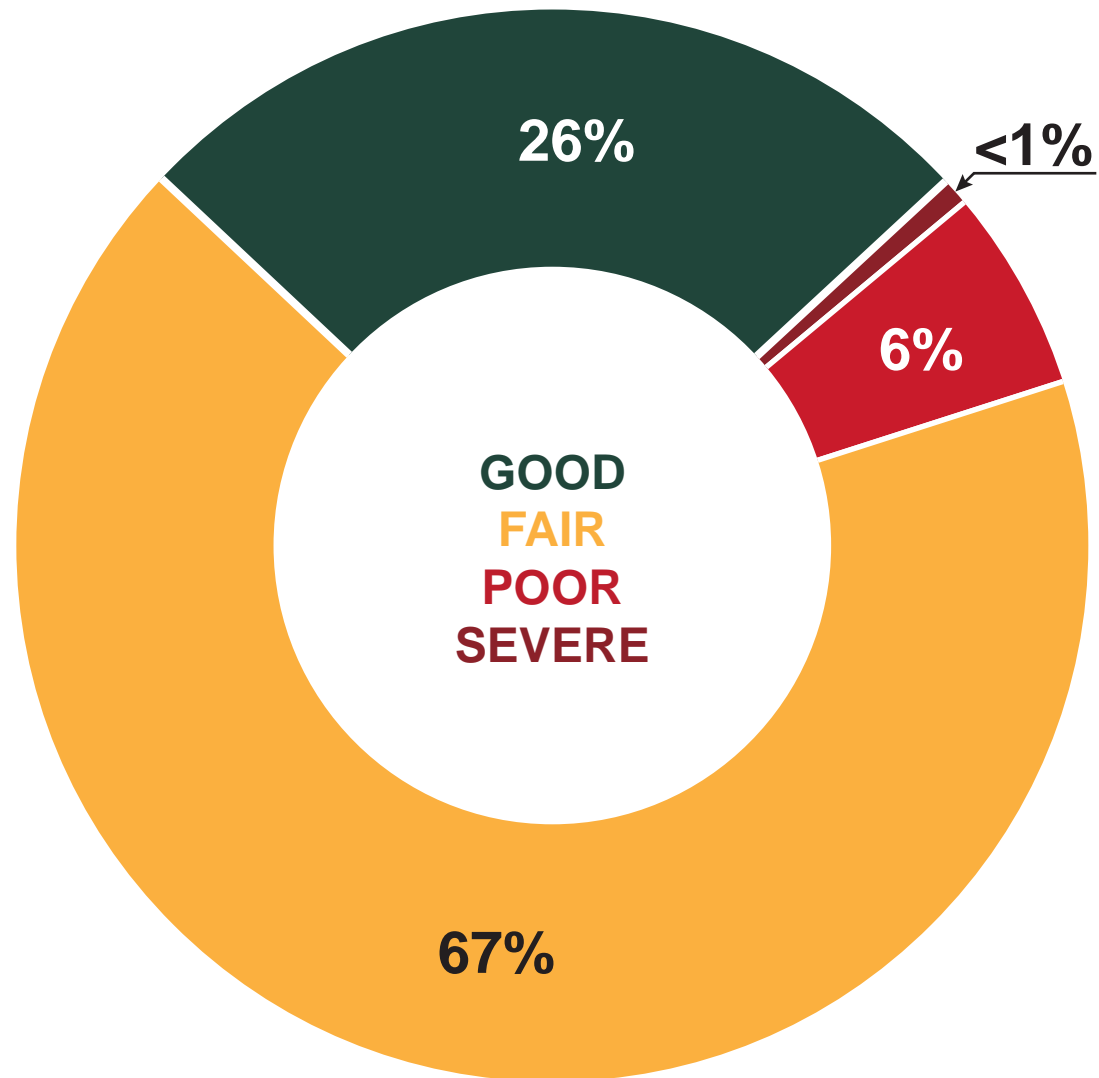

Figure 10

Source: 2020 National Bridge Inventory



I-94 Grand River Bridge Construction, Jackson

# 2020 Local Agency Bridge Condition

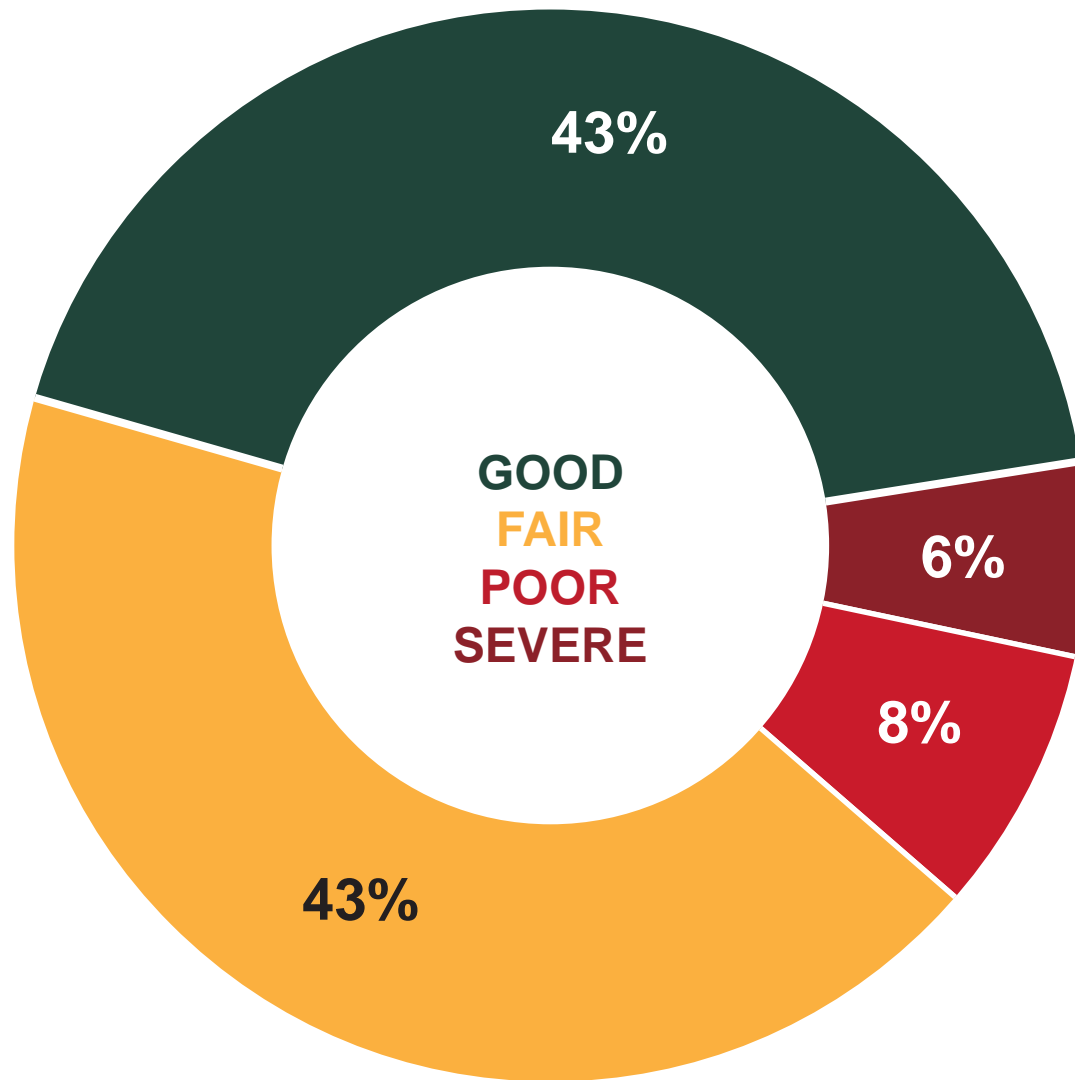

Figure 11

Source: 2020 National Bridge Inventory

# Local Agency Bridges

Figure 11 shows that local agencies are managing both a larger percentage of good bridges, while also managing a larger percentage of poor and severe bridges. While many local agencies are working to embrace preservation strategies but are prevented by the overwhelming need of the bridges in the worst conditions.

A bridge in poor condition is a candidate for major rehabilitation or replacement. When the bridge no longer has the strength to bear the loads for which it was designed, the bridge must be posted for lower loads in order to maintain safety. A bridge in severe condition often needs expensive emergency repairs, temporary supports, or shoulder closures. Ultimately, the inability to obtain funding will result in a safety risk to the public and the bridge must be closed.

At the end of 2020, 62 local agency bridges were closed due to their condition.

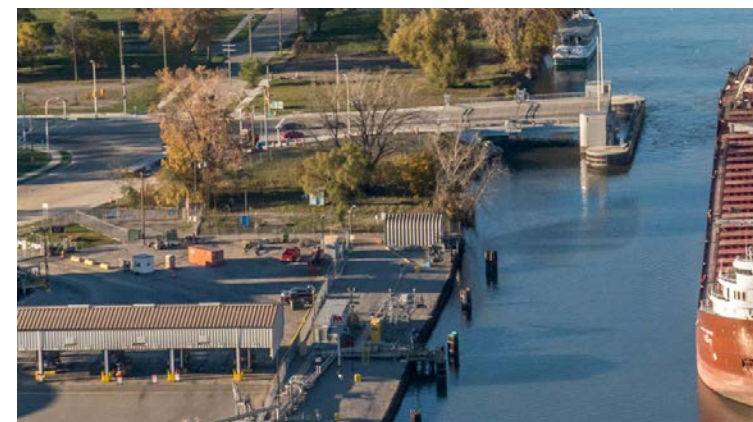



# Bridge Cycle of Life

Every year, analysts examine the bridge data to determine the extent to which bridges are improved or deteriorate over a 4-year span. This effort tracks how bridges change from between the good, fair, and poor ratings and is referenced as the Bridge Cycle of Life.

Figure 12 shows over 7.8% more bridges have deteriorated than have been improved between 2017-2020.

In simplified terms, the deteriorating bridges outpaces the ability to repair or replace them.



# Bridge Cycle of Life

All Bridges 2017-2020

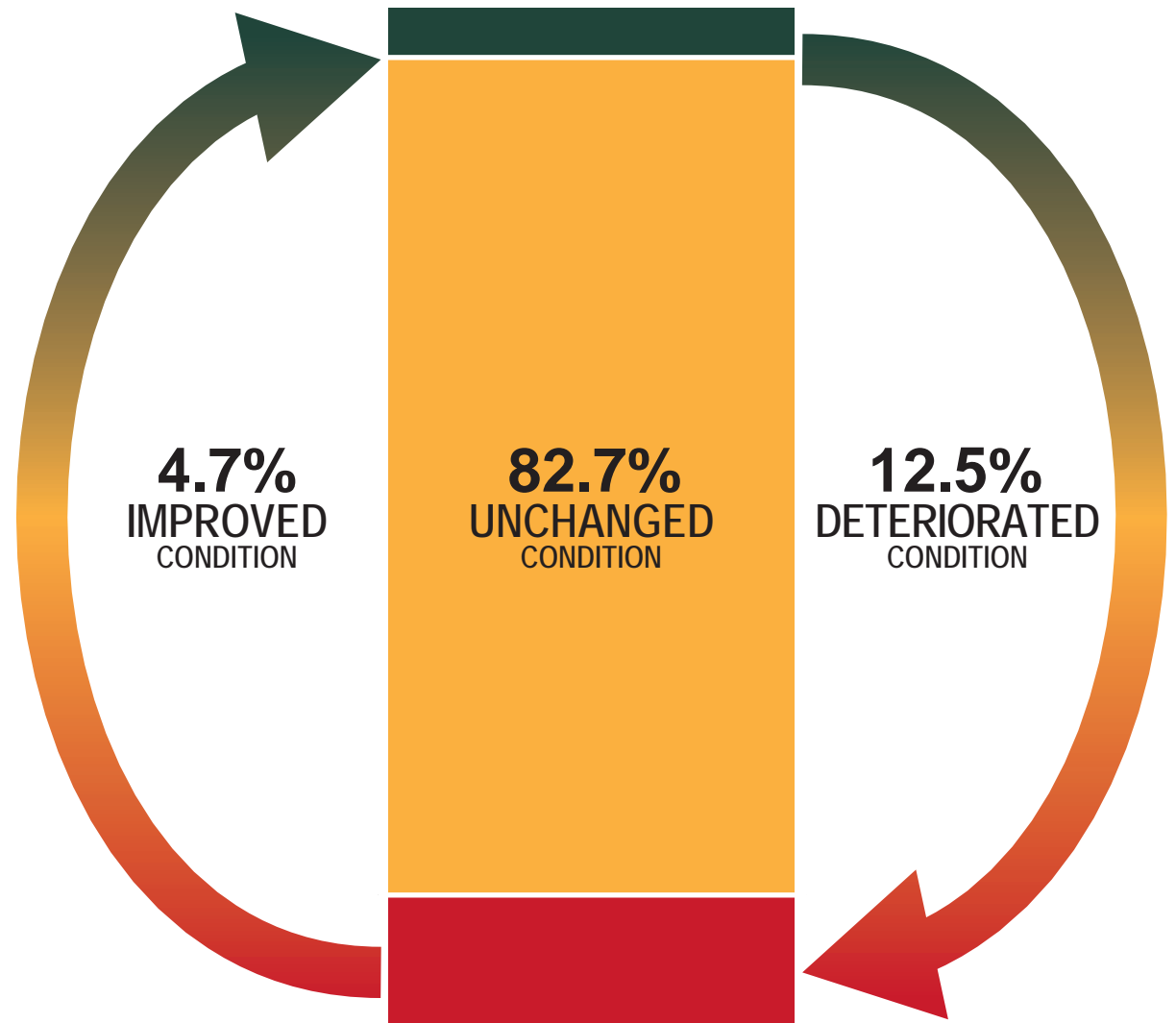

**Bridges Declined 7.8%**

Figure 12

Source: 2017-2020 Michigan Bridge Inventory

# Bridge Condition Forecast

2022-2032

# Bridge Condition Forecast

Working from current bridge condition information (NBI), bridge deterioration rate, project costs, expected inflation, and fix strategies, the Bridge Condition Forecasting System (BCFS) estimates future condition of bridges. Figure 13 indicates the combined overall bridge condition of all Michigan's bridges is expected to continue to decline after 2020.

While additional funding has been approved for the state level trunkline bridges, no new funds were earmarked specifically for local bridge programs. Therefore, this forecast assumes no additional spending on bridges beyond those funds already designated for that purpose.

This forecast also includes the severe condition category that continues to rise. Over 20% of all bridges are forecast to be in the poor or severe category by the year 2032. This indicates additional bridges will be at high risk and lead to more emergency repairs and closures without additional investment for bridge programs.

PERCENT BRIDGE CONDITION

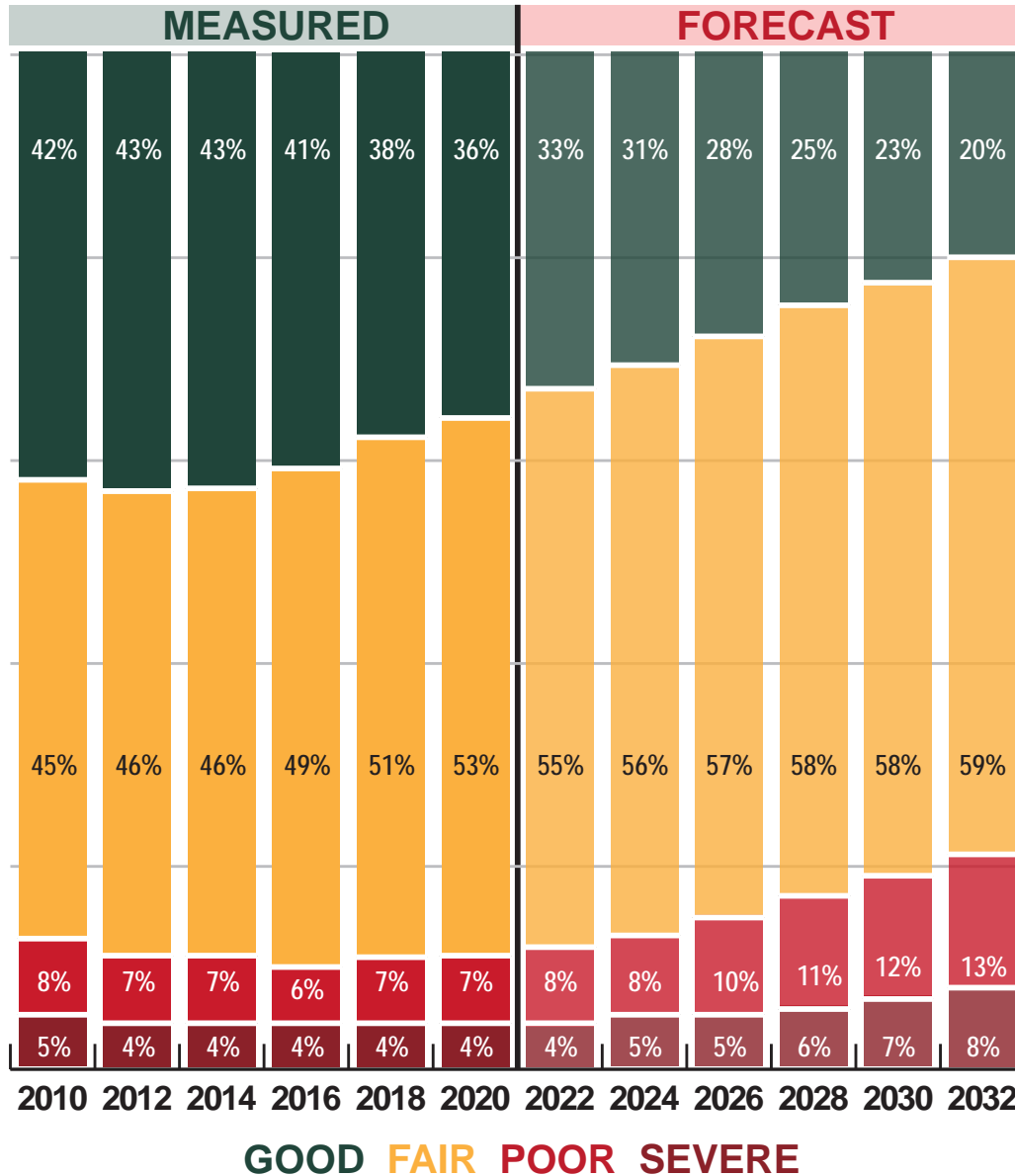
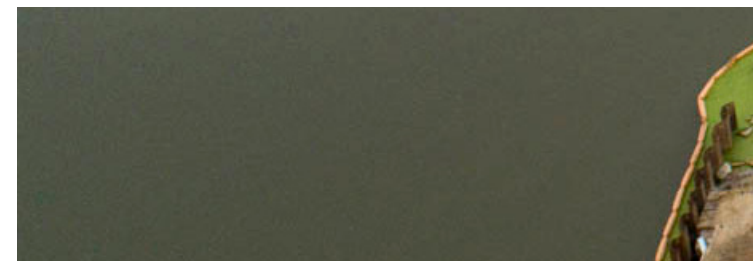

Figure 13  
Source: 2021 TAMC





# INVESTMENT REPORTING



# Investment Reporting Tool (IRT)

The IRT is a free tool developed to allow all Michigan road owning agencies to satisfy the requirements of Act 51. The basic requirement is to report road and bridge projects they have completed and projects that are planned in the next three years.

Beyond required reporting, a road agency can use the IRT as a tool to manage its road and bridge assets with customized maps, data exports, and a variety of summary reports. The ability to import STIP planned projects already entered by MPO's into another reporting tool called JobNet, marked a major accomplishment, two years in the making. Other IRT features include:

- Options to import JobNet major planned projects (NEW)
- Submission of warranties and asset management plans
- Project reporting options with Roadsoft software
- PASER submission and review for planning agencies
- Free training with online webinars
- Help desk and YouTube videos

Additionally, the interactive map in the IRT can display project information for presentations and public outreach. TAMC welcomes feedback on the IRT to improve usability, data quality, and efficiency.

What follows in this section are summaries of the IRT road and bridge data and average costs. This information is used to help refine forecasting efforts and investigate statewide investment strategies and other initiatives.

Michigan.gov  
TAMC ABOUT TAMC Dave Jennett - Bay County

## Investment Reporting Tool (IRT)

Projects + Add Map Reports

Welcome  
**Bay County**

Total Road Miles: 1,030.672  
Total Bridges: 77

Road Projects with ADARS Information: 186 (of 296)  
ADARS Fiscal Year: January 1, 2021 - December 31, 2021

Last Asset Management Plan Submitted: Jun 4, 2020  
Next IRT Submittal Due Date: Apr 30, 2022  
TAMP Submission Due Date: October 1, 2020

299 Entered Projects Fiscal Years 2018 - 2020  
71 Planned Projects Fiscal Years 2021 - 2023

Currently showing Overview data as Fiscal Years  
Change to display as Calendar Years

Michigan.gov  
TAMC ABOUT TAMC Dave Jennett - Bay County

## Investment Reporting Tool (IRT)

Projects + Add Map Reports

Revilo Rd  
2019 Poor 3

Download All Projects as CSV

Road Projects

Year	Project ID/Name
2020	200263

Classification: Heavy CPM

PASER Road Rating: PR 772104  
2019 Fair 7

Download All Projects as CSV

Michigan.gov  
TAMC ABOUT TAMC Dave Jennett - Muskegon County

## Investment Reporting Tool (IRT)

Projects + Add Map Reports

Michillinda Rd  
2019 Fair 7

Download All Projects as CSV

Road Projects

Year	Rating
2019	3-Po

Michigan.gov  
TAMC ABOUT TAMC Dave Jennett - City of Tawas City

## IRT

Projects + Add Map Reports

Search by ID, Name, Description, Comment, or Road Segment

Type Classification  
Improvement Type Warranty Information  
Calendar Year Date Range

Pages: Page 1 of 13 Projects per page: 10

Clear Form Export Map View +Add Project



Drake Road, Kalamazoo County

# Road Project Details

A summary of 2018-2020 completed road projects submitted to the IRT can be seen in Figure 14. At the time of analysis, only a portion of the 2020 data was available as agencies report according to their fiscal year.

A list of average costs compiled from 2018-2020 IRT road projects can be seen in Figure 15. For analysis and forecasting efforts, it is important to recognize different costs depending on the type of project or “mix of fixes.” Cost averages can vary based on road size, traffic volumes and weight carried. National Functional Classification (NFC) helps define

these characteristics by listing “minor roads” as NFC 7, “main roads” as NFC 3-6 and “freeways / interstates” as NFC 1-2. Figure 19 reveals two key factors:

- Significant cost increase when Capital Preventive Maintenance options are no longer viable.
- The need to maintain Good and Fair condition roads to prevent the deterioration into Poor condition.

With over 40% of roads statewide in poor condition, the vast amount of pavement work and required rehabilitation or reconstruction, stresses the need for new investment in the billions.

Road IRT Project Summaries			
Year	Projects Reported	Total Cost	Total Lane Miles
2018	5,548	\$1.14 Billion	18,911
2019	5,660	\$1.84 Billion	20,118
2020	2,484	\$1.37 Billion	9,235
<b>Total:</b>	<b>13,692</b>	<b>\$4.35 Billion</b>	<b>48,264</b>

Figure 14  
Source: 2018-2020 TAMC

Average Cost for Different Road Work	Cost Per Lane Mile		
	Minor Road (NFC 7)	Main Road (NFC 3-6)	Major Highway (NFC 1-2)
Light Capital Preventive Maintenance	\$10,754	\$22,675	\$33,687
Heavy Capital Preventive Maintenance	\$46,251	\$72,518	\$89,696
Rehabilitation	\$191,058	\$259,605	\$531,000
Reconstruction	\$661,395	\$916,562	\$1,701,000

Figure 15  
Source: 2018-2020 TAMC

# Bridge Project Details

Investment in bridge projects vary from year to year as seen in Figure 16, with a range of \$110M to \$362M with roughly \$693M reported from 2018-2020.

Of Michigan’s 617 road agencies, 352 own and maintain bridges. Of Michigan’s 11,000 bridges, approximately half are owned by MDOT and half by local road agencies. Bridges can vary substantially in their length, deck area and other factors. However, replacing a bridge often greatly impacts the local economy as well as emergency services regardless of agency size.

Figure 17 shows a sample of IRT reported replacement bridge projects. A typical “small bridge” could be a 60-foot single span crossing with two lanes of traffic where a “large bridge” may cross longer distances, have additional lanes, and carry heavier commercial traffic.

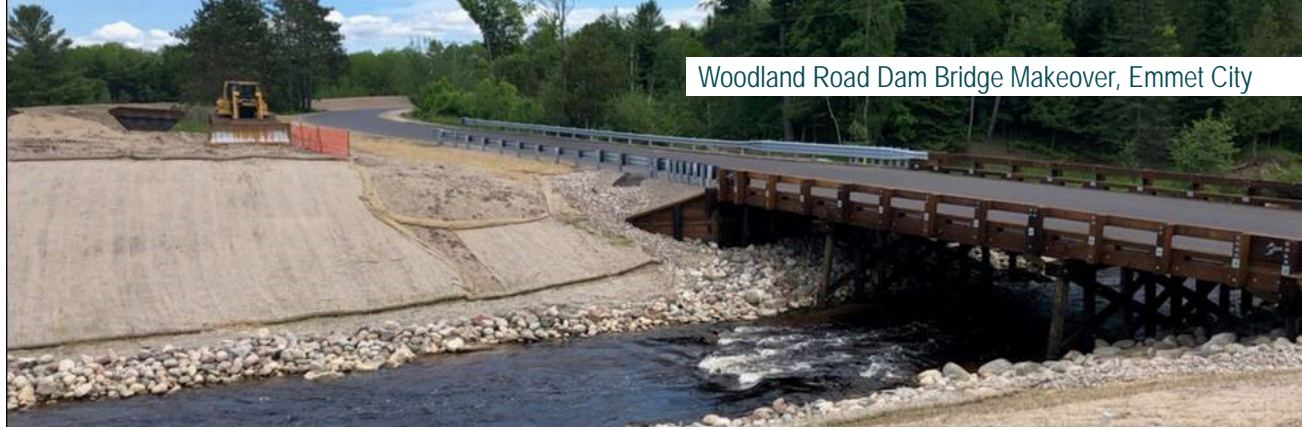

Woodland Road Dam Bridge Makeover, Emmet City

Sustained funding and preventive maintenance are even more critical for a bridge. The cost to replace a bridge for a small road agency may be more expensive than maintaining all the roads they own.

Note: The Rouge River Bridge, Zilwaukee Bridge and other large bridges are not included in statewide totals, since the high cost of this type of project would significantly shift totals and averages.

Bridge IRT Project Summaries			
Year	Projects Reported	Total Cost	Agencies Reporting Bridge Projects
2018	206	\$110 Million	51
2019	257	\$362 Million	49
2020	303	\$221 Million	44
<b>Total:</b>	<b>766</b>	<b>\$693 Million</b>	<b>86 (unique)</b>

Figure 16  
Source: 2018-2020 TAMC

## Sample Replacement Costs

Small and Large Bridges

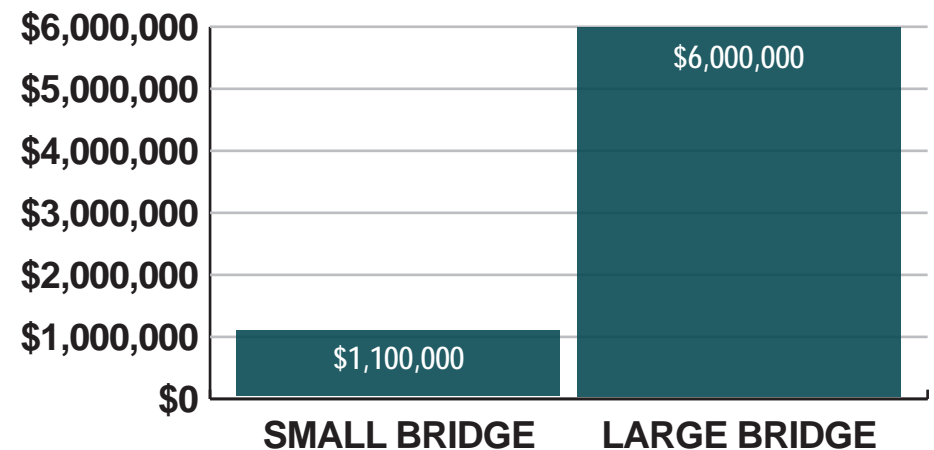

Figure 17  
Source: 2018-2020 TAMC



M-55 Cooley Bridge, Manistee County

# Taking a Look at Asset Management

Asset management tools can aid in the timing of preventive maintenance being applied to prevent significant reconstruction costs once roads or bridges deteriorate into poor condition.

Figure 18 is a depiction showing deterioration occurring over time along with improvement options that can bring a road back into good condition. It is important to note that the cost of maintenance and rehabilitation is substantially less than the cost of reconstruction and can be completed several times over the lifespan of a road reconstruction.

In general terms, Michigan must use asset management best practices to save the roads and bridges currently in good and fair condition.

However, as seen in the previous road and bridge project and condition summaries – **substantial investment in the billions of dollars is needed** to allow for further “mix of fixes” to address Michigan’s aging and critical infrastructure.



**ROAD DETERIORATION**

Figure 18

Source: 2020 TAMC





I-94 Nokmes Outlet Makeover, New Buffalo

# Asset Management Survey

The intent of the IRT’s Asset Management Survey focused on gathering additional information on how agencies manage their road and bridge assets. It also served as a precursor to legislation requiring larger agencies to submit formal TAMPs to the TAMC. The effort provides agencies the option to upload an asset management plan or documents that have assisted in their asset management process.

As seen Figure 19, of the 617 road owning agencies, almost one third indicated that they have a written asset management plan, while over half of all agencies use an asset management process.

How Agencies Are Using Asset Management Practices	Response		
	Yes	No	Blank
Questions From IRT Asset Management Survey (617 Road Owning Agencies)			
1. Does your agency have a written Asset Management Plan?	187	430	N/A
2. Does your agency use an asset management process?	341	145	131
3. Does your agency have separate plans or condition goals for the Primary Road/Major Street versus the Local Road/Street networks?	288	197	132
4. Does your agency use pavement management software or tools to identify and prioritize future road projects?	264	223	130
5. Does your agency use a variety of preventive maintenance and rehabilitation treatments for roads?	442	45	130
6. Does your agency plan road projects 3 or more years in advance?	348	140	129

Figure 19  
Source: 2020 TAMC

A photograph of a dirt road winding through a forest with vibrant autumn foliage. The road is light brown and shows tire tracks. The trees are in shades of yellow, orange, and green. A semi-transparent white banner is overlaid at the top of the image.

# LOOKING INTO 2021



South Brand Avenue, Clare County

## Culverts 2.0

2021 ramps up the culvert discussion as official collection policies, guidance manuals, new training incorporating national standards, and lessons learned from the 2018 Culvert Inventory Pilot, are all underway. There is new technology for culvert condition data submission which mirrors PASER condition data. This will streamline the process and maintain quality data for this often overlooked, but key component of infrastructure.

## TAMC Conferences

With added worldwide attention to asset management, TAMC continues to support conferences that showcase Michigan's road-owning agency efforts, national trends, and internationally recognized speakers. The TAMC conferences promote the spirit of teamwork and provides opportunity to learn and share experiences with peers. Whether in person, virtual, or a hybrid of the two platforms, asset management is still all about collaboration.

## PASER 2021 - Mission 100%

The federal-aid road condition rating collection process is typically 100% coverage over a 2-year period. 2020 had no federal-aid roads rated due to COVID-19, so a new pilot policy which uses 2-person teams vs. traditional 3-person teams is one adaptation TAMC is pursuing. "Adapt and Overcome" continues to be the theme in 2021.

## The MIC Project Portal Now Live

The MIC "Dig Once" Project Portal allows authorized public and private asset owners to document future construction locations/dates across, transportation, water, utilities, and communications infrastructure. Leveraging Geographic Information Systems (GIS) technology, the portal alerts owners of overlapping projects and provides pertinent contact information for collaboration.

[www.Michigan.gov/MIC](http://www.Michigan.gov/MIC)

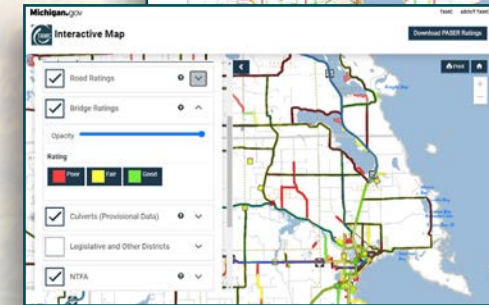
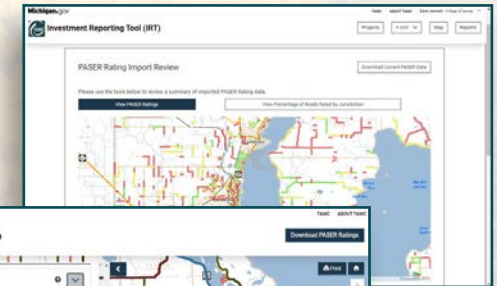

## Technology Advancements

TAMC continues to stay on pace with new technology advancements. There are considerable upgrades on the entire GIS mapping environment commonly known as "Framework." In addition, update efforts to ADARS are underway. Both projects pose opportunities and challenges in efficiency and accuracy in many TAMC program areas.



Moon Lake Bridge Construction, Jackson County

**“All public roads in Michigan will be managed  
using the principles of asset management”**

- Public Act (PA) 499 of 2002 created the Michigan TAMC

**Michigan.gov/TAMC**

